

Self-contained Proximity Sensors

EZ/EV Series

Features

- Compact sensor head
- Visible output indicator built into sensor
- Flexible cable joint
- IP-67-rated housing

Detecting Distance

DC 3-wire – Up to 10 mm

DC 2-wire – Up to 27 mm



Description

Space-saving

With a sensor body up to 30% shorter than previous models, the EZ/EV Series proximity sensor offers high sensitivity and long detecting distance.

Easy-to-see output indicator

An output indicator is built into the sensor unit in such a manner that sensor operation can be easily confirmed from virtually any angle.

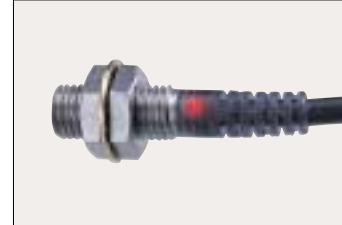

Flexible joint

The cable is connected to the sensor head with a highly flexible joint that can be bent to a 90-degree angle, thus preventing cable wire breakage.

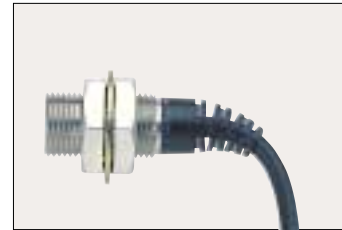

Outstanding tightening-strength

The sensor housing has a thick tough wall, enabling it to be securely tightened. This prevents the sensor from becoming loose due to vibration or shock.



2-wire type reduces wiring cost

Wiring time and labour is reduced by one-third compared to 3-wire types. Wiring errors also decrease.



Standard model

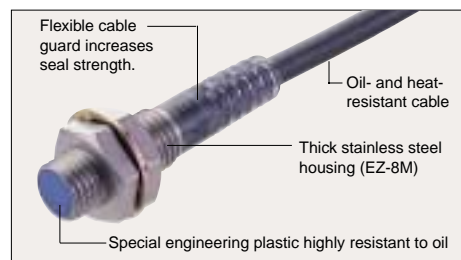

Specifications

DC 3-wire type

Type		Shielded				
Model	NPN	EZ-8M	EZ-12M	EZ-18M	EZ-30M	EZ-18T
Size		M8	M12	M18	M30	20 x 32 x 8 mm
Detecting distance		1.5 mm ±10%	2.5 mm ±10%	5 mm ±10%	10 mm ±10%	5 mm ±10%
Detectable object		Ferrous metals (see Characteristics for nonferrous metals)				
Standard target (iron, t=1 mm)		10 x 10 mm	12 x 12 mm	18 x 18 mm	30 x 30 mm	18 x 18 mm
Hysteresis		10% max. of detecting distance				
Response frequency		800 Hz	600 Hz	350 Hz	250 Hz	350 Hz
Temperature fluctuation		10% max. of detecting distance at +23°C (-25 to +70°C)				
Operation mode		N.O./N.C.				
Control output		100 mA max. (40 V max.), Residual voltage: 1 V max.				
Power supply		12 to 24 VDC ±10%	12 to 24 VDC ±10%	12 to 24 VDC ±10%	12 to 24 VDC ±10%	12 to 24 VDC ±10%
Current consumption		13 mA max.	13 mA max.	13 mA max.	13 mA max.	13 mA max.
Enclosure rating		IP-67	IP-67	IP-67	IP-67	IP-67
Ambient temperature		-25 to +80°C	-25 to +80°C	-25 to +80°C	-25 to +80°C	-25 to +80°C
Cable length		2 m	2 m	2 m	2 m	2 m
Weight (including cable and nuts)		Approx. 50 g	Approx. 65 g	Approx. 130 g	Approx. 235 g	Approx. 55 g

DC 2-wire type

Type		Shielded			Non-shielded		
Model	NPN	EV-108M	EV-112M	EV-118M	EV-112U	EV-118U	EV-130U
Size		M8	M12	M18	M12	M18	M30
Detecting distance		1.5 mm ±10%	2.5 mm ±10%	5 mm ±10%	8 mm ±10%	15 mm ±10%	27 mm ±10%
Detectable object		Ferrous metals (see Characteristics for nonferrous metals)					
Standard target (iron, t=1 mm)		10 x 10 mm	12 x 12 mm	18 x 18 mm	30 x 30 mm	50 x 50 mm	70 x 70 mm
Hysteresis		10% max. of detecting distance			20% max. of detecting distance (-10 to +70°C)		
Response frequency		800 Hz	600 Hz	350 Hz	600 Hz	350 Hz	250 Hz
Temperature fluctuation		±10% max. of detecting distance at +23°C (-25 to +70°C)			±10% max. of detecting distance (-10 to +70°C)		-5 to +20% (-10 to +70°C)
Operation mode		N.O. (N.C. output type available for all models)					
Control output (switching capacity)		5 to 80 mA	5 to 200 mA	5 to 200 mA	5 to 200 mA	5 to 200 mA	5 to 200 mA
Protection circuit		Reversed polarity, surge voltage	Reversed polarity, short-circuit, surge voltage				
Power supply		12 to 24 VDC					
Ratings		Current consumption (leakage current): 1.0 mA max., Residual voltage: 3.6 V max. (with 2-m cable)					
Enclosure rating		IP-67	IP-67	IP-67	IP-67	IP-67	IP-67
Ambient temperature		-25 to +80°C	-25 to +80°C	-25 to +80°C	-25 to +80°C	-25 to +80°C	-25 to +80°C
Housing		Stainless steel	Nickel-plated brass	Nickel-plated brass	Nickel-plated brass	Nickel-plated brass	Nickel-plated brass
Cable length		2 m	2 m	2 m	2 m	2 m	2 m
Weight (including cable and nuts)		Approx. 42 g	Approx. 110 g	Approx. 150 g	Approx. 110 g	Approx. 140 g	Approx. 260 g

1 Photoelectric Sensors
 2 Safety Light Curtains
 3 Proximity Sensors
 4 Pressure Sensors
 5 Programmable Logic Controllers
 6 Counters, Control Units
 7 High-Precision Sensors
 8 Vision Systems
 9 Bar Code Readers
 10 Displacement Sensors
 11 Thinbeam Measuring Instruments
 12 Analog Sensor Controllers
 13 Video Microscope
 14 Technical Guide

Connections

EZ Series: DC 3-wire type

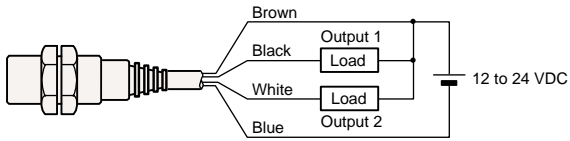

Black (output 1): N.O.
White (output 2): N.C.

EV Series: DC 2-wire type

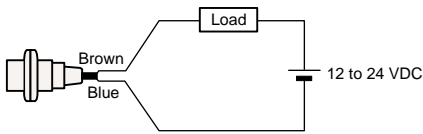

Connection to built-in DC power supply type PLC
(externally connected power supply)

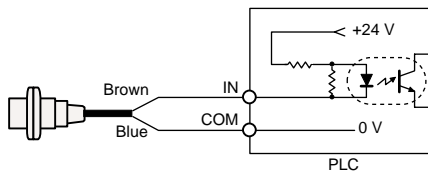

Connection to built-in DC power supply type PLC
(internally connected power supply)

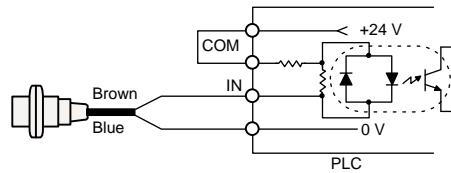

Connection to PLC having no internal DC power supply

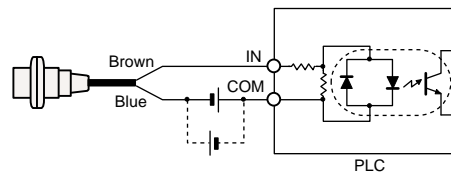

For connections indicated by the dotted lines,
reverse brown and blue sensor wires.

Output Circuits

EZ Series DC 3-wire type

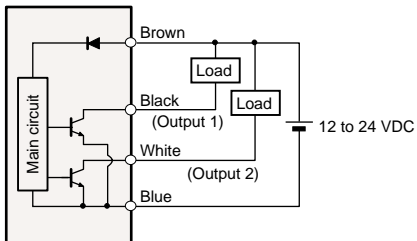

EV Series DC 2-wire type*

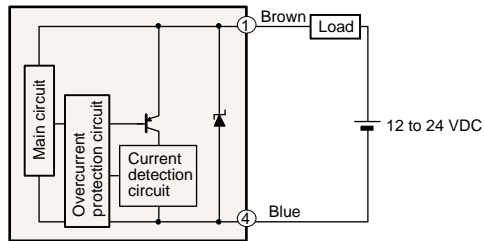

* The M8 sensor does not contain short-circuit protection or a current detection circuit.
(1) and (4) in the circuit diagram shows the pin number of the connector type.

Characteristics

Detecting range (Typical)
DC 3-wire type

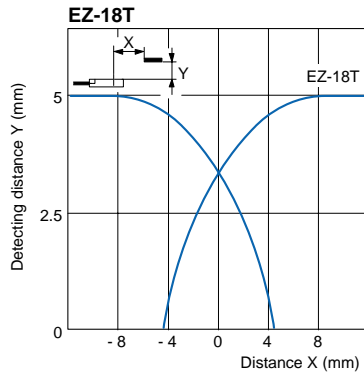
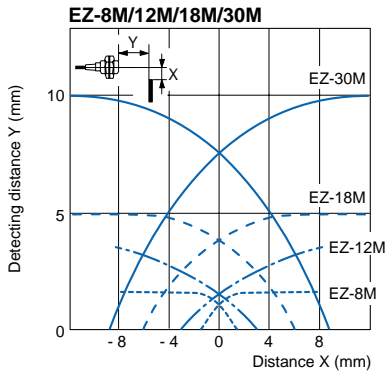

DC 2-wire type

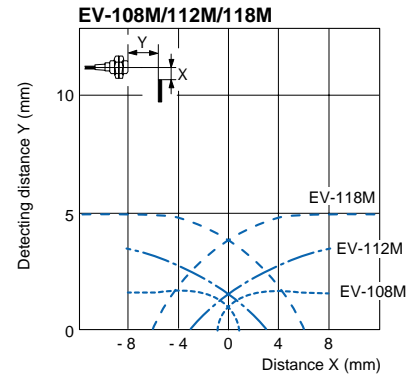

Detecting distance vs. size and material of target (Typical)
DC 3-wire type

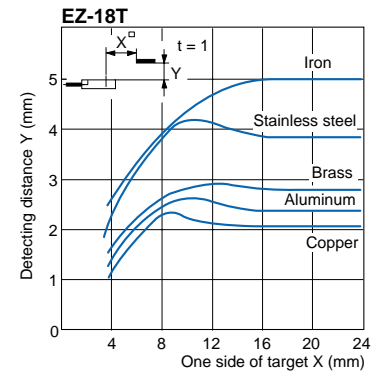
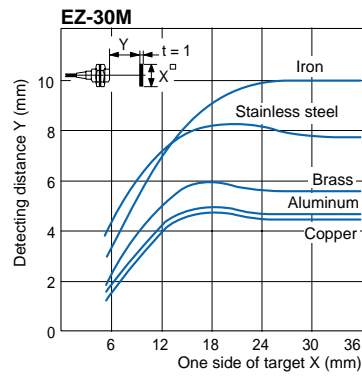
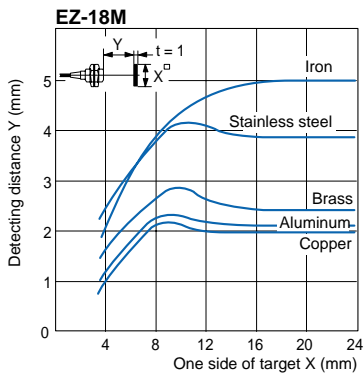
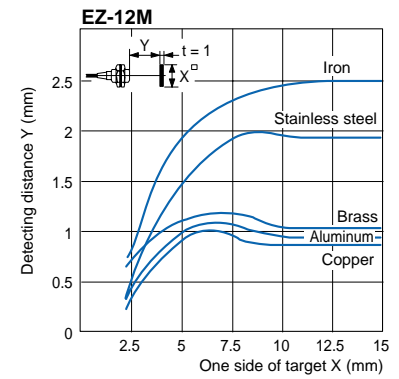
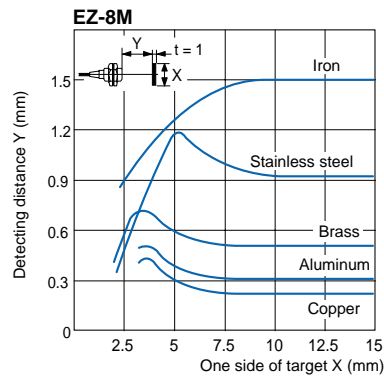
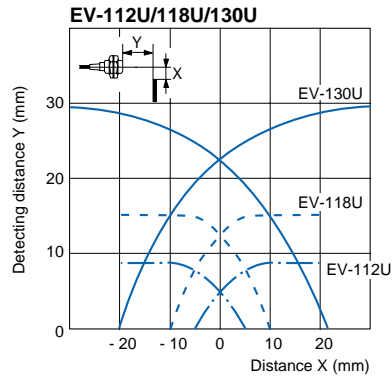

DC 2-wire type

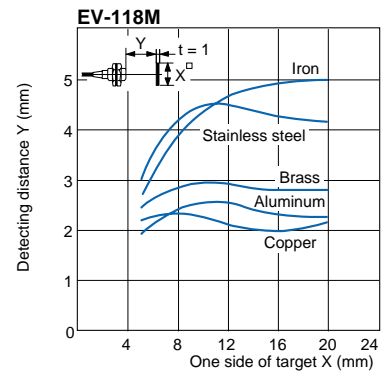
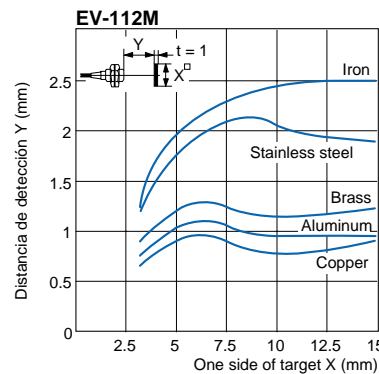
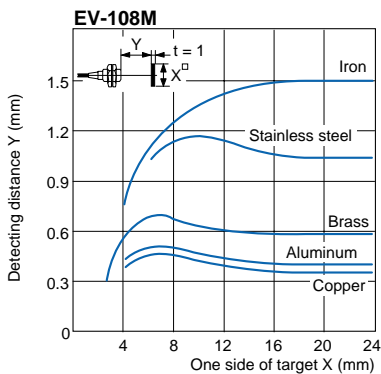

- 1 Photoelectric Sensors
- 2 Safety Light Curtains
- 3 Proximity Sensors
- 4 Pressure Sensors
- 5 Programmable Logic Controllers
- 6 Counters/Control Units
- 7 High-Precision Sensors
- 8 Vision Systems
- 9 Bar Code Readers
- 10 Displacement Sensors
- 11 Thinbeam Measuring Instruments
- 12 Analog Sensor Controllers
- 13 Video Microscope
- 14 Technical Guide

Detecting distance vs. size and material of target (Typical) DC 2-wire type

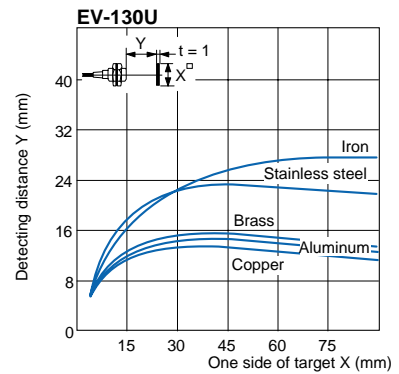
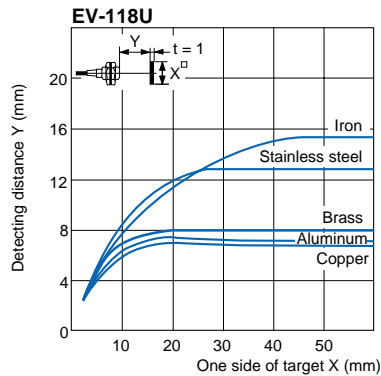
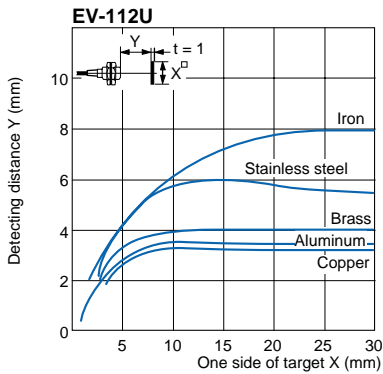

Residual voltage (Typical)

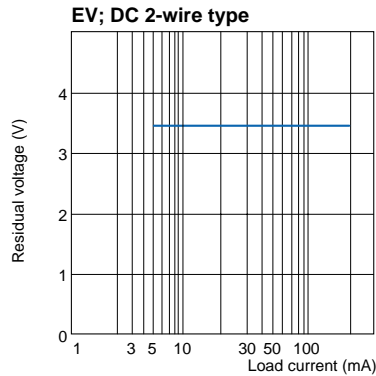

Leakage current (Typical)

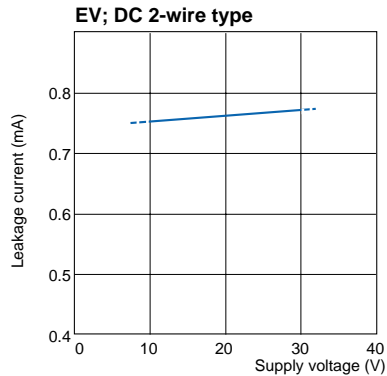

Hints on Correct Use

Mounting

When mounting the sensor, insert the attached toothed washer. Do not tighten beyond the torque specified in the following table.

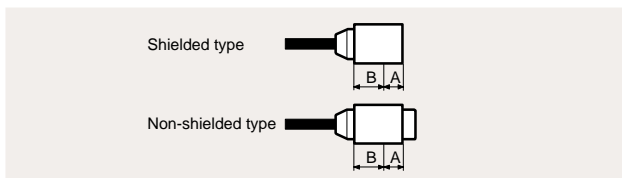

Model	Dimension A (mm)	Tightening torque	
		At A	At B
EZ-8M	3	3 N•m max.	5 N•m max.
EV-108M	3	8 N•m max.	9 N•m max.
EZ-12M	6	6 N•m max.	10 N•m max.
EZ-18M	6	15 N•m max.	20 N•m max.
EV-112M, EV-112U	6	15 N•m max.	30 N•m max.
EV-118M, EV-118U	7	60 N•m max.	70 N•m max.
EZ-30M	10	50 N•m max.	100 N•m max.
EV-130U	10	120 N•m max.	180 N•m max.

Wiring

The sensor cable may be extended up to 100 m (EZ Series), or 200 m (EV Series).

Surrounding metal

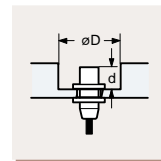

Shielded-type sensors can be flush-mounted in a metal base. Sensors of the non-shielded type, however, should be mounted according to the guidelines given below in order to minimize interference from the surrounding metal.



Model	D (mm min.)	d (mm min.)
EV-112U	55	20
EV-118U	70	25
EV-130U	120	28

Interference

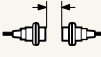
When installing 2 or more sensors of the same model face-to-face or in parallel, separate by the distance specified in the following table to prevent interference.

Distance	Face-to-face (mm min.)	Parallel (mm min.)
Model		
EZ-8M	20	23
EZ-12M	30	32
EZ-18M	40	48
EZ-30M	100	100
EV-108M	20	11
EV-112M	30	22
EV-118M	40	28
EV-112U	55	62
EV-118U	70	88
EV-130U	160	180
EZ-18T	40	35

Effects of leakage current

With a 2-wire proximity sensor, a small amount of current flows (leakage current) to keep the circuit operating even when the sensor is turned OFF. (Refer to graph "Leakage current characteristics".)

Because of this current, a low voltage remains on the load, sometimes preventing the load from properly resetting. Before operation, check that the residual voltage is lower than the reset voltage of the load.

When the load current is low

When the load current is less than 5 mA, connect a bleeder resistor to give the sensor 5 mA or more load current. Make sure the residual voltage is less than the reset voltage of the load.

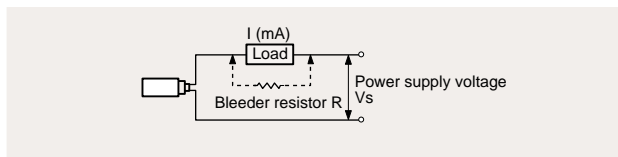

Calculate the resistance (R) and rated bleeder resistor wattage (P) from the following expressions:

DC 2-wire type:

$$R \leq \frac{V_s - 3.6^*}{5 - I} \text{ (k)} \quad P > \frac{V_s^2}{R} \text{ (mW)}$$

V_s : Power supply voltage (V)

I: Load current (mA)

P: Rated wattage of bleeder resistor

* 3.6 V is the rated residual voltage.

DC 2-wire type (EV Series)

If a relay is connected as the load, confirm that the dropout voltage of the relay is sufficiently higher than the sensor's residual voltage of 3.6 V. (A 12 VDC relay cannot be activated.)

Protection circuits of DC 2-wire type (EV Series)

- Since this sensor incorporates short-circuit protection (not applicable to M8 type), direct connection of the power supply to the sensor does not cause the sensor to break down. However, the sensor will not be able to perform detection. Connect the brown cable to the positive terminal of the power supply and the blue cable to the negative terminal.
- This sensor incorporates a reversed-polarity protection circuit. However, reverse connection of the power supply to the sensor without a load may damage the sensor.

- 1 Photoelectric Sensors
- 2 Safety Light Curtains
- 3 Proximity Sensors
- 4 Pressure Sensors
- 5 Programmable Logic Controllers
- 6 Counters, Control Units
- 7 High-Precision Sensors
- 8 Vision Systems
- 9 Bar Code Readers
- 10 Displacement Sensors
- 11 Thinbeam Measuring Instruments
- 12 Analog Sensor Controllers
- 13 Video Microscope
- 14 Technical Guide

Dimensions

Unit: mm

DC 3-wire type

EZ-8M

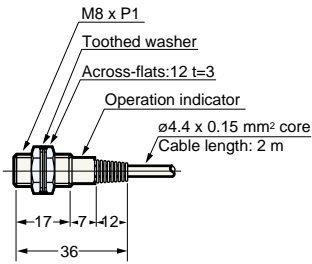

EZ-12M

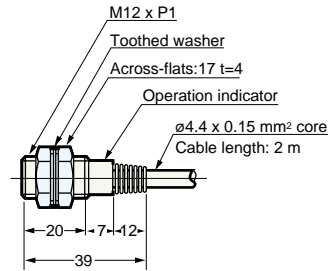

EZ-18M

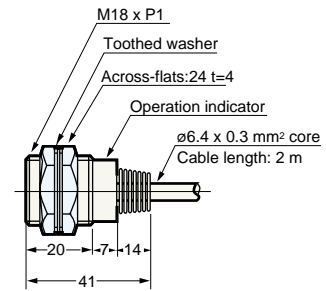

EZ-30M

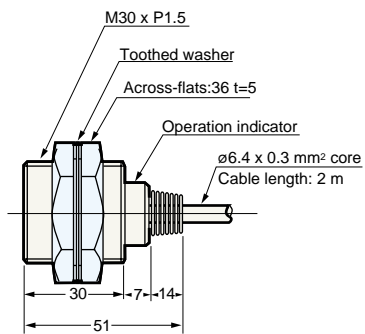

EZ-18T

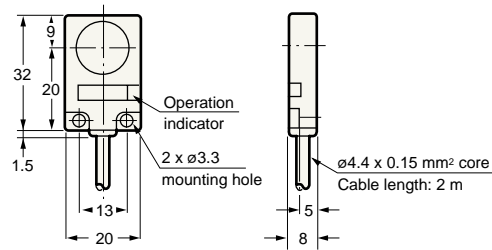

DC 2-wire type

EV-108M

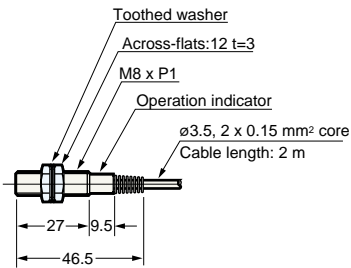

EV-112M

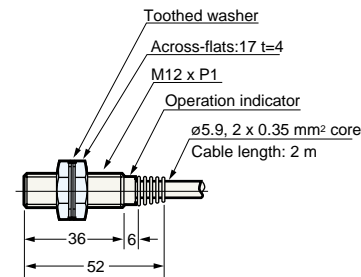

EV-118M

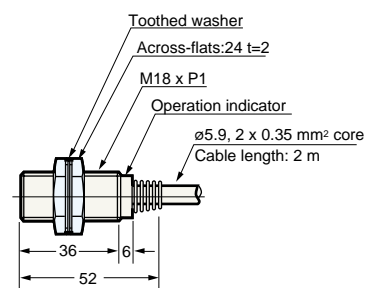

EV-112U

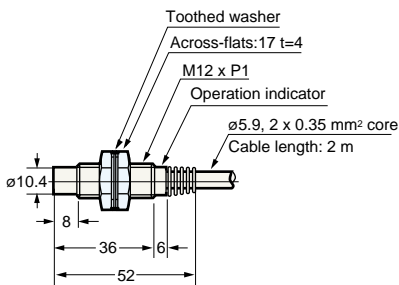

EV-118U

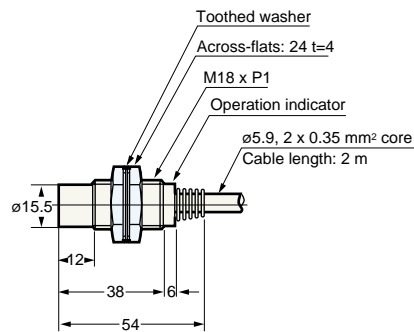

EV-130U

